

UDC 621.914.22

## INFLUENCE OF OBLIQUE GEOMETRY OF CUTTING INSERTS OF FINISHING FACE MILLS ON CUTTING FORCES

Heorhii Vyhovskiy<sup>1</sup>; Nataliia Balytska<sup>1, 2</sup>; Mykola Plysak<sup>1</sup>;  
Valentyn Otamanskyi<sup>1</sup>

<sup>1</sup>Zhytomyr Polytechnic State University, Zhytomyr, Ukraine

<sup>2</sup>Technische Universität Dresden, Germany

**Summary.** The feasibility of using face milling for the final formation of the parts surface layer is confirmed by a large number of scientific works. At the same time, there are significant advantages of technological processes using face mills for oblique cutting, equipped with superhard materials, with a spiral-stepped arrangement of cutting inserts. This work is devoted to the study of the influence of the inclination angle of the oblique face mill cutting edge on the cutting forces when processing the workpiece flat surface made of gray cast iron and carbon tool steel using the Deform-3D program. The influence of the cutting edge inclination in the range from 0 to -45° on the smoothness of penetration of the face mill inserts into the workpiece is discussed.

**Key words:** face milling, simulation, oblique cutting, cutting forces, finishing

[https://doi.org/10.33108/visnyk\\_tntu2022.04.054](https://doi.org/10.33108/visnyk_tntu2022.04.054)

Received 12.12.2022

**Statement of the problem.** The increasing requirements for the reliability of machines make it necessary to improve the technological processes of manufacturing products with the use of new finishing machining methods. Ensuring the high quality of the surfaces of machine parts by technological methods is one of the urgent tasks of modern engineering production.

One of the parameters characterizing the competitiveness of machines and mechanisms is the reliability of their operation, which is always limited by one or another detail or component unit. This is especially relevant if the unit operates under the influence of aggressive environments, without lubrication, in contact with particles of abrasive materials, etc. Therefore, it is urgent to increase the service life of machine parts by using new materials and innovative technologies. Ensuring the reliability of products for difficult operating conditions requires the improvement of technological processes that guarantee the high quality of the surfaces of parts during mechanical processing.

One of the ways to enhance the quality of forming the surface layer is to improve the existing and develop new designs of cutting tools based on the analysis of kinematics and characteristics of the machining process. Recently, face milling processes using tools equipped with superhard materials (SHM) have become widespread [1–4]. Processing with SHM cutters is characterized by high productivity, quality characteristics of the surface layer, etc. However, most designs of face mills implement a conventional cutting scheme with distribution of allowance by feed, which significantly reduces the actual number of cutters involved in cutting and worsens the dynamics of the milling process. Designs of spiral-stepped cutters for oblique cutting with vertexless cutting inserts made of SHM have significant advantages. The use of such cutters makes it possible to increase productivity and quality of machining, to foster the process of cutting the minimum thicknesses of the cut layers, which are typical for fine machining, and monotonous cutting edges with relatively large radii allow to reduce the load per unit length of the cutting edge, which increases wear resistance and machining productivity [5–7]. At the same time, the non-stationarity of the cutting process, which is characteristic of

face milling processes, leads to variable deformations of the technological system. During machining, significant cutting forces occur, which change their magnitude and direction of action, and lead to processing errors in the transverse direction due to dynamic deformations of the technological system. In the longitudinal direction (in the feed direction), machining errors are primarily related to the variability of the milling width in the areas where the cutter cuts into the workpiece and at the exit. The variable milling width leads to fluctuations in the cutting forces at the entry/exit of the cutting inserts into/from the cutting zone, to variable deformations of the technological system and longitudinal profile errors. Therefore, the reduction of machining errors in order to increase the accuracy of the processed part and improve the physical and mechanical properties of the surface layer is of crucial importance in finishing face milling [8–10].

**Evaluation of the latest researches and publications.** A number of studies [5–10] have established the high efficiency of the application of face stepped milling cutters of oblique cutting, equipped with SHM for semi-finishing and finishing of flat surfaces of cast iron and steel hardened parts.

In works [11–13], the authors investigated a number of factors (machining conditions, nature of wear and destruction, etc.) that affect the performance of face mills equipped with SHM during finish milling of gray cast iron and hardened steels. Based on the obtained results, the authors draw conclusions about the expediency of using a certain brand of tool material: Hexanit-R (composite-10), Elbor (composite-1), Kyborit. The specified tool materials provide the ability to perform processing at high cutting speeds and maintain high cutting capacity. In [14, 15], the cutting properties of various composites and their significant differences during intermittent cutting of hardened steels are described. The authors [15] showed that composite 10 has the greatest resistance under such conditions. However, with increased allowances for milling on the cutting edges, the appearance of thermal cracks perpendicular to the main cutting edges is possible, which leads to chipping of the tool material particles and ultimate wear [9, 16, 17].

According to the results of research [5], the high efficiency of using tipless cutters of oblique geometry, equipped with composite 10, with negative angles of inclination of cutting edges ( $\lambda$ ) and the use of rear cylindrical surfaces of cutting inserts with radii of 6–14 mm was confirmed. Data analysis shows that cutting speed affects all components of cutting forces  $F_x$ ,  $F_y$ ,  $F_z$ . At  $\lambda=0^\circ$  and  $\lambda=+45^\circ$ , the components of the cutting forces have higher values than at  $\lambda=-45^\circ$ , that is, more intensive wear of cutter inserts can be assumed at  $\lambda=0^\circ$  and  $\lambda=+45^\circ$ . Therefore, the use of negative values of the angle of inclination of the cutting edge reduces the  $F_x$ ,  $F_y$ ,  $F_z$  components of the cutting force, which in turn allows to reduce the specific loads per unit length of the cutting edge. In [18], it was also noted that when the angle  $\lambda$  increases from  $0^\circ$  to  $+45^\circ$ , the force  $F_z$  acting in the direction of the cutting speed vector increases by no more than 5%, and when the angle is  $\lambda > 45^\circ$ , the force  $P_z$  increases sharply. The obtained data indicate an increase in the stability of the tools when the angle  $\lambda$  increases, while it is determined that the optimal value of the inclination angle of the cutting edge lies within  $\lambda = +60^\circ \dots 75^\circ$  (for hardened steels and hard-to-machine materials). According to [19], an increase in the angle of inclination  $\lambda$  from  $+40^\circ$  to  $+60^\circ$  leads to a decrease in stability by 1.5 times, which is explained by a decrease in the active area of the cutting edge and an increase in the load per unit of its length.

In works [20, 21], when turning samples from alloyed steels XBF (similar to 107WCR5, 48–50 HRC) and IIX-15 (similar to 100Cr6, 60–62 HRC), it was established that the cutting speed exerts the greatest influence on the temperature in the contact zone  $v$  and the angle of inclination  $\lambda$  of the cutting edge of the tool, and the cutting depth and feed have a smaller effect, although the temperature increases less intensively with the increase of the latter than with the increase of the cutting depth. Analysis of experimental data shows

that with an increase in the inclination angle of the cutting edge  $\lambda$ , the cutting temperature increases. So, according to the calculation, when the angle of inclination of the cutting edge  $\lambda$  increases from  $+30$  to  $+60^\circ$  ( $t = 0.1$  mm,  $v = 1.4$  m/s,  $h_z = 0.1$  mm,  $f = 0.67$  mm/rev) the average contact temperature increases from 800 to 1030 °C [20]. It has been shown that the life of oblique single-sized tools and inserts having cylindrical rake face in turning the hardened steel (60–62 HRC) with feeds up to 0.6 and 1 mm/rev is from 40 to 110 min, respectively [21].

Literary sources on the values of the components of cutting forces in oblique tipless face milling are quite scarce, and the reviewed sources, when researching cutting forces, show that it is necessary to take into account the entire set of processing conditions in each specific case. The study and solution of the considered issues, which are aimed at increasing the performance of spiral-stepped face mills equipped with SHM, for the finishing of flat surfaces is an urgent task and has a great importance for mechanical engineering.

To reduce the amount of real-time research of cutting processes, simulation of machining processes by the finite element method (FEM) in such programs as Abaqus, AdvantEdge, Ansys, Deform-3D, etc. has become widely used at present [22–26]. To simulate the face milling process, the Deform-3D program was chosen, which is characterized by relative ease of use, a convenient interface and allows obtaining a stable result.

**Research objective.** To determine the influence of the negative inclination angle of the oblique face mill cutting edge on the cutting forces when machining the workpiece flat surface of gray cast iron and carbon tool steel using the Deform-3D program.

**Objective statement.** On the basis of the designed computer model [27] in the DEFORM-3D program, which is based on the finite element method, for the conditions of face oblique milling with a single insert equipped with an superhard tool material (hexanite-P), it is necessary to investigate the influence of negative angles the inclination of the cutting edges  $\lambda$  on the cutting forces when the insert blade cuts into the workpiece.

Simulation conditions: oblique milling of gray cast iron CЧ21 (similar to EN-GJL-200, 170HB) and carbon steel Y8 (C80W, 46 HRC); cutting speed  $v = 2.5$  m/s; feed  $f_z = 0.625$  mm/tooth; cutting depth  $t = 0.12$  mm; the tool is a single-tooth face mill with a diameter of 360 mm, the tool material is hexanite-R, the simulation time is 0.21 ms. Geometry of cutting plates: flat front surface, front angle  $\gamma = -10^\circ$ , rear angle in the direction of the cutting speed vector  $\alpha_v = 12^\circ$  (Fig. 1–2). The angle of inclination of the main cutting edges varied from  $\lambda=0^\circ$  to  $\lambda= -45^\circ$ .

The 3D model of the workpiece with a preliminary cut was developed in the SolidWorks Motion module according to the method described in [22]. The calculation in Deform-3D took into account the mechanical behavior of the processed materials, which is described by the Johnson-Cook equation [28, 29].

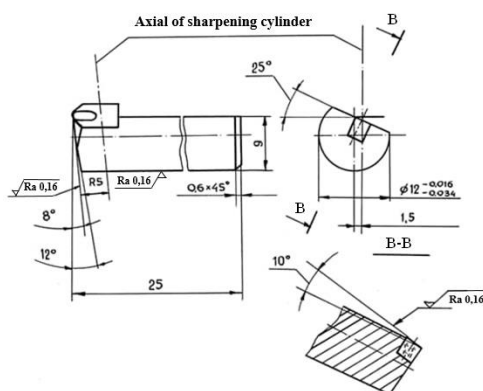
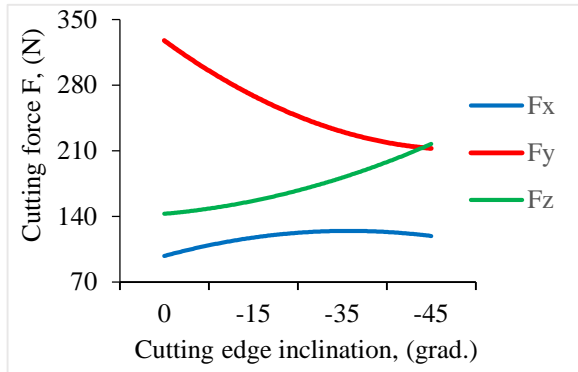

Figure 1. Design of the cutting insert [3]

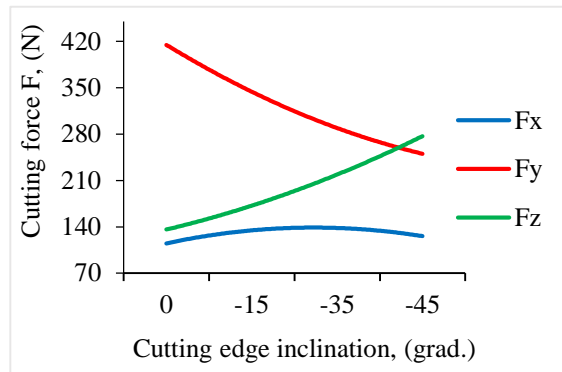

Figure 2. 3D-model of the cutting insert

The obtained results of the maximum values of the cutting force components  $F_x$ ,  $F_y$ ,  $F_z$  during the time interval of cutting the insert into the workpiece depending on the angle of inclination of the cutting edge  $\lambda$  for processing gray cast iron and carbon tool steel are shown in Fig. 3 and 4.



**Figure 3.** Dependence of the cutting force components  $F_x$ ,  $F_y$ ,  $F_z$  on the cutting edge inclination during milling of gray cast iron



**Figure 4.** Dependence of the cutting force components  $F_x$ ,  $F_y$ ,  $F_z$  on the cutting edge inclination during milling of hardened carbon tool steel

The simulation results make it possible to conclude that the use of negative values of the angle of inclination of the cutting edge  $\lambda$  significantly reduces the component of the cutting force  $F$ , which in turn will reduce the load per unit length of the cutting edge and increase the wear resistance of the cutting plates. At the same time, the  $F_z$  component increases and the axial  $F_x$  component changes slightly. Despite the relatively small values of the axial cutting force  $F_x$ , they cause elastic movements of the cutter body. Fluctuations in cutting forces lead to constant changes in these movements, as a result of which there is an imprint of the cutting elements that form the surface of the part. This causes processing errors, while their values determine the deviation from the ideal trajectory of the cutting edge of the tool, which affects the shape of the parts and the quality characteristics of the surface layer [30–35].

Figures 5–7 demonstrate the graphs of the dependence of the cutting force components on the cutting edge inclination  $\lambda$  when cutting the insert of a face mill into a workpiece made of gray cast iron.

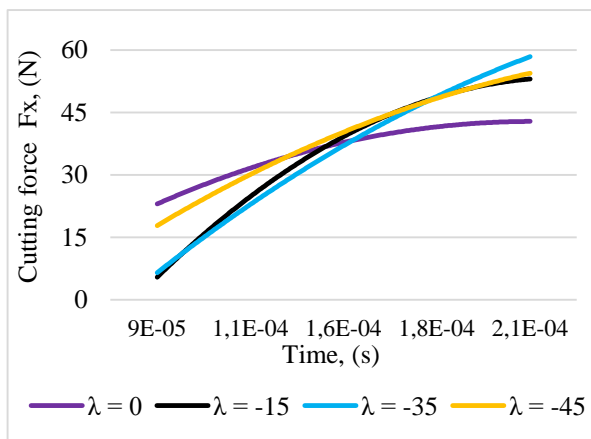

**Figure 5.** Dependence of the cutting force component  $F_x$  on the cutting edge inclination  $\lambda$  when cutting the insert into the workpiece made of gray cast iron

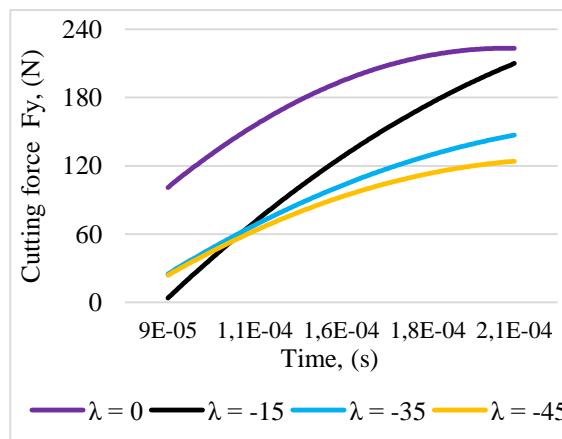

**Figure 6.** Dependence of the cutting force component  $F_y$  on the cutting edge inclination  $\lambda$  when cutting the insert into the workpiece made of gray cast iron

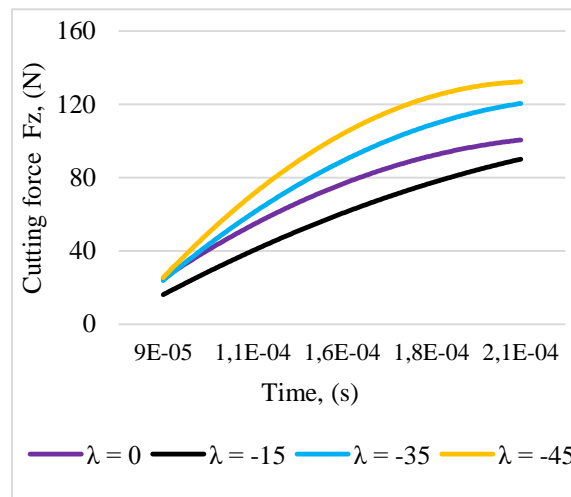

**Figure 7.** Dependence of the cutting force component  $F_z$  on the cutting edge inclination  $\lambda$  when cutting the insert into the workpiece made of gray cast iron

The following conclusions can be drawn from the above results of computer simulation (Figs. 5–7) of the process of penetration of the cutting edge of an oblique end mill into a workpiece made of gray cast iron. The use of negative values of the angle of inclination of the cutting edge  $\lambda$  during cutting significantly reduces the component of the cutting force  $F_y$  for  $\lambda=-35^\circ$  and  $\lambda=-45^\circ$ , which, in turn, will have a positive effect on the milling process. Simultaneously, when employing the cutting edge angle of  $\lambda=-45^\circ$ , the  $P_z$  component increases significantly, compared to angles of  $\lambda=0^\circ$ ,  $\lambda=-15^\circ$ . The obtained results on the axial component of  $P_x$  indicate that when using the angles  $\lambda=-15^\circ$ ,  $\lambda=-35^\circ$ , a smoother cutting of the cutting blade into the workpiece will be ensured in comparison with  $\lambda=0^\circ$ ,  $\lambda=-45^\circ$ .

Figures 8–10 show the graphs of dependence of the cutting force component  $F_z$  on the cutting edge inclination  $\lambda$  when cutting the insert into the workpiece made of carbon steel.

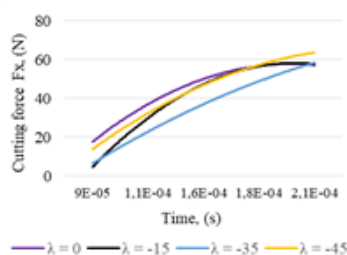

**Figure 8.** Dependence of the cutting force component  $F_x$  on the cutting edge inclination  $\lambda$  when cutting the insert into the workpiece made of hardened carbon tool steel

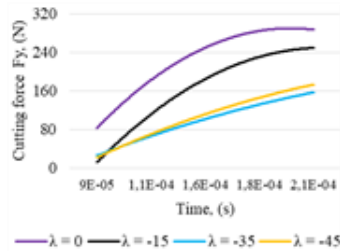

**Figure 9.** Dependence of the cutting force component  $F_y$  on the cutting edge inclination  $\lambda$  when cutting the insert into the workpiece made of hardened carbon tool steel

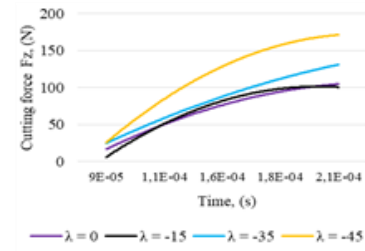

**Figure 10.** Dependence of the cutting force component  $F_z$  on the cutting edge inclination  $\lambda$  when cutting the insert into the workpiece made of hardened carbon tool steel

The following conclusions can be drawn from the results of the computer simulation of the process of penetration of the cutting edge of an oblique end mill into a workpiece made of carbon steel (Fig. 8–10). The use of negative values of the angle of inclination of the cutting edge  $\lambda$  during milling significantly reduces the component of the cutting force  $F_y$  for  $\lambda=-35^\circ$ ,  $\lambda=-45^\circ$ . However, when using the inclination angle  $\lambda=-45^\circ$ , the  $F_z$  component increases significantly. At  $\lambda=-35^\circ$ , a decrease in the values of the axial component of the cutting force  $F_x$

is observed. Based on the obtained results, it can be said that the application of an inclination angle of  $\lambda=-35^\circ$  will ensure the smoothest penetration of the cutting plate into the workpiece, which, in turn, will have a positive effect on the quality of the machined surface and the efficiency of the milling process as a whole.

Thus, as the obtained results show, by changing the angle of inclination of the cutting edge of the face mill insert from  $\lambda=0^\circ$  to  $\lambda=-45^\circ$ , it is possible to significantly influence the value and ratio of the cutting force components during the time interval of cutting the insert into the workpiece.

**Conclusions.** Using computer simulation of the process of cutting of an oblique face mill insert into a grey cast iron and carbon steel workpiece, the influence of the cutting edge inclination angle in the range  $\lambda=0^\circ$  to  $\lambda=-45^\circ$  on the  $F_x$ ,  $F_y$ ,  $F_z$  cutting forces components was determined. It was found that the use of negative values of  $\lambda$  significantly reduces the  $F_y$  component of the cutting force, which in turn reduces the load per unit length of the cutting edge and increases the wear resistance of the inserts. However, the  $F_z$  component increases and the  $F_x$  component of the cutting force changes slightly.

The application of the angle of inclination  $\lambda=-35^\circ$  ensures the smoothest cutting of the insert into the workpiece, which increases the stability of the tool and the quality of the machined surface.

The obtained results can be applied in the design of oblique cutting tools of various types, the prediction of the technological system deformations and the quality of the flat surfaces of the parts to be machined.

## References

1. Stephenson D. A., Agapiou J. S. Metal cutting theory and practice. CRC Press, 2016, 931 p. <https://doi.org/10.1201/b19559>
2. Grzesik W. Machining of hard materials. In: Machining, Springer, London, 2008. P. 97–126. [https://doi.org/10.1007/978-1-84800-213-5\\_4](https://doi.org/10.1007/978-1-84800-213-5_4)
3. Uhlmann E., Sammler F., Barry J., Fuentes J., Richarz S. Superhard Tools. In: Laperrière, L., Reinhart, G. (eds) CIRP Encyclopedia of Production Engineering. Springer, Berlin, Heidelberg, 2014. P. 1183–1188. [https://doi.org/10.1007/978-3-642-20617-7\\_6411](https://doi.org/10.1007/978-3-642-20617-7_6411)
4. Vyhovskyi H. M. Pidvyshchennia pratsездatnosti tortsevykh frez dlia chystovoi obrobky ploskykh poverkhon. Diss. kand. tek. nauk. Kyiv, 2000. 16 p. [In Ukrainian].
5. Hlembotska L., Melnychuk P., Balytska N., Melnyk O. Modelling the loading of the nose-free cutting edges of face mill with a spiral-stepped arrangement of inserts, Eastern-European Journal of Enterprise Technologies. Vol. 9. No. 1. P. 46–54. <https://doi.org/10.15587/1729-4061.2018.121712>
6. Stepchyn Ya. A. Porivnialna kharakterystyka dynamiky protsesiv tortsevoho frezeruvannia frezamy standartnykh ta spetsialnykh konstruktсии. Visnyk ZhDTU. Seriiia “Tekhnichni nauky”. Vol. 72. No. 1. 2016. P. 51–56. [In Ukrainian].
7. Hromovyi O. A., Vyhovskyi H. M., Balytska N. O. Shliakhy udoskonalennia protsesu obrobky ploskykh poverkhon detalei frezeruvanniam. Tekhnichna inzheneriia. Vol. 86. No. 2. 2020. P. 48–53. [In Ukrainian]. URL: [https://doi.org/10.26642/ten-2020-2\(86\)-48-53](https://doi.org/10.26642/ten-2020-2(86)-48-53).
8. Muñoz-Escalona P., Maropoulos P. G. A geometrical model for surface roughness prediction when face milling Al 7075-T7351 with square insert tools. Journal of Manufacturing Systems. Vol. 36. 2015. P. 216–223. <https://doi.org/10.1016/j.jmsy.2014.06.011>
9. Hlembotska L., Balytska N., Melnychuk P., Vyhovskyi H. Structural improvement of face mills designs based on systems approach. Scientific Journal of TNTU. Vol. 101. No. 1. 2021. P. 102–114 [https://doi.org/10.33108/visnyk\\_tntu2021.01.102](https://doi.org/10.33108/visnyk_tntu2021.01.102)
10. Schultheiss F., Bushlya V., Lenrick F., Johansson D., Kristiansson S., J.E. Ståhl. Tool wear mechanisms of pcBN tooling during high-speed machining of gray cast iron. Procedia CIRP. Vol. 77. 2018. P. 606–609. <https://doi.org/10.1016/j.procir.2018.08.201>
11. Soshi M., Fonda P., Kashiwara M. et al. A study on cubic boron nitride (CBN) milling of hardened cast iron for productive and quality manufacturing of machine tool structural components. Int. J. Adv. Manuf. Technol. Vol. 65. 2013. P. 1485–1491. <https://doi.org/10.1007/s00170-012-4272-3>
12. Sahin Y. Comparison of tool life between ceramic and cubic boron nitride (CBN) cutting tools when machining hardened steels. Journal of Materials Processing Technology. Vol. 209. No. 7. 2009. P. 3478–3489. <https://doi.org/10.1016/j.jmatprotec.2008.08.016>

13. Smith G. T. Cutting Tool Technology. Industrial Handbook, Springer-Verlag, GmbH, 2008, 600 p.
14. Novikov N. V., Klimenko S. A. Instrumenty iz sverkhтвердыkh materialov. Moscow: Mashinostroenie, 2014. 608 p. [In Russian]
15. Cui X., Zhao J., Tian X. Cutting forces, chip formation, and tool wear in high-speed face milling of AISI H13 steel with CBN tools. *Int. J. Adv. Manuf. Technol.* Vol. 64. 2013. P. 1737–1749. <https://doi.org/10.1007/s00170-012-4137-9>
16. Kumar Wagri N., Petare A., Agrawal A., Rai R., Malviya R., Dohare S., Kishore K. An Overview of the Machinability of Alloy Steel. *Materials Today. Proceedings.* Vol. 62. No. 6. 2022. P. 3771–3781. <https://doi.org/10.1016/j.matpr.2022.04.457>
17. Ivanov I. U. Frezerovanie korpusnykh i bazovykh detalei frezami osnashchennymi reztsami iz elbora-R. *Tekhnologiya proizvodstva, nauchnaia organizatsiia truda i upravleniia.* Vol. 2. 1979. P. 26–31. [In Russian].
18. Shevchenko N. A., Kipper E. E. Chistovye lezviinye instrumenty s bolshim uglom naklona rezhushchikh lezviy. *Nadezhnost rezhushchego instrumenta.* Vol. 2. 1975. P. 222–228. [In Russian].
19. Klimenko S. A., Manokhin A. S. Tverdoe breiushchee tochenie. *Sverkhтвердые материалы.* Vol. 1. 2009. P. 58–74. [In Russian].
20. Klimenko S. A., Manokhin A. S., Melniichuk Y. A. Wear and life of tools with inserts from cBN-based polycrystalline superhard materials in the finish turning of hardened steels at heavy feeds. *Journal of Superhard Materials.* Vol. 34. No. 1. 2012. P. 49–55. <https://doi.org/10.3103/S1063457612010066>
21. Daoud M., Chatelain J. F., Bouzid A. Effect of rake angle on Johnson-Cook material constants and their impact on cutting process parameters of Al2024-T3 alloy machining simulation. *Int. J. Adv. Manuf. Technol.* Vol. 81. 2015. P. 1987–1997. <https://doi.org/10.1007/s00170-015-7179-y>
22. Shrot A., Bäker M. Is it possible to identify Johnson-Cook law parameters from machining simulations? *International Journal of Material Forming.* Vol. 3. 2010. P. 443–446. <https://doi.org/10.1007/s12289-010-0802-4>
23. Tapoglou N., Antoniadis A. 3-dimensional kinematics simulation of face milling. *Measurement.* Vol. 45. No. 6. 2012. P. 1396–1405. <https://doi.org/10.1016/j.measurement.2012.03.026>
24. Hlembotska L., Balytska N., Melnychuk P., Melnyk O. Computer modelling power load of face mills with cylindrical rake face of inserts in machining difficult-to-cut materials. *Scientific Journal of TNTU.* Vol. 93. No. 1. 2019. P. 70–80. [https://doi.org/10.33108/visnyk\\_tntu2019.01.070](https://doi.org/10.33108/visnyk_tntu2019.01.070)
25. Li G., Rahim M. Z., Pan W., Wen C., Ding S. The manufacturing and the application of polycrystalline diamond tools – A comprehensive review. *Journal of Manufacturing Processes.* Vol. 56. 2020. P. 400–416. <https://doi.org/10.1016/j.jmapro.2020.05.010>
26. Dobrotvorsky S. S., Basova E. V., Dobrovolskaya L. G. Computer design and simulation of technological processes of high-speed milling of hardened steels. *Bulletin of Lviv Polytechnic National University.* Vol. 822. 2015. P. 1–6.
27. Vyhovskiy H., Plysak M., Balytska N., Hlembotska L., Otamanskyi V. Numerical Simulation of Cutting Forces in Face Milling. *Advanced Manufacturing Processes IV. InterPartner 2022. Lecture Notes in Mechanical Engineering*, Springer, Cham, 2023. P. 222–231. [https://doi.org/10.1007/978-3-031-16651-8\\_21](https://doi.org/10.1007/978-3-031-16651-8_21)
28. Chernykh D. M., Tkachenko Yu. S., Tsyganov V. S. Simulation of the machining process in order to optimize the operating parameters. *Bulletin of the Voronezh State Technical University.* Vol. 15. No. 1. 2019. P. 130–137.
29. Vovk A., Sölter J., Karpuschewski B. Finite element simulations of the material loads and residual stresses in milling utilizing the CEL method. *Procedia CIRP.* Vol. 87. 2020. P. 539–544. <https://doi.org/10.1016/j.procir.2020.03.005>
30. Sheth S., George P. M. Experimental investigation and prediction of flatness and surface roughness during face milling operation of WCB material. *Procedia Technol.* Vol. 23. 2016. P. 344–351. <https://doi.org/10.1016/j.protcy.2016.03.036>
31. Vyhovskiy H., Plysak M., Balytska N., Melnyk O., Hlembotska L. Engineering methodology for determining elastic displacements of the joint “spindle assembly-face milling cutter” while machining planes. In: *Advanced Manufacturing Processes II. InterPartner 2020. Lecture Notes in Mechanical Engineering*. Springer, Cham, 2021. P. 258–268. [https://doi.org/10.1007/978-3-030-68014-5\\_26](https://doi.org/10.1007/978-3-030-68014-5_26)
32. Wu W. P. Investigation of the effects of face-milling parameters of ultra-large-scale plane on milling quality. *Int. J. Adv. Manuf. Technol.* Vol. 37. 2008. P. 241–249. <https://doi.org/10.1007/s00170-007-0976-1>
33. Sheth S., George P. Experimental investigation and optimization of flatness and surface roughness using grey relational analysis for WCB material during face milling operation. *Advances in Intelligent Systems Research.* Vol. 137. 2017. P. 65–70. <https://doi.org/10.2991/iccasp-16.2017.11>
34. Chauhan P., Patel S., Patel K. Experimenting and predicting flatness and surface roughness during face milling operation of CF8M grade A-351. In: *International Conference on Research and Innovations in Science. Engineering & Technology.* Vol. 1. No. 1. 2017. P. 537–547. URL: <https://doi.org/10.29007/dcj5>

35. Borysenko D., Karpuschewski B., Welzel F., Kundrák J., Felhő C. Influence of cutting ratio and tool macro geometry on process characteristics and workpiece conditions in face milling. *CIRP Journal of Manufacturing Science and Technology*. Vol. 24. 2019. P. 1–5. <https://doi.org/10.1016/j.cirpj.2018.12.003>

#### Список використаних джерел

1. Stephenson D. A., Agapiou J. S. *Metal cutting theory and practice*. CRC Press, 2016. 931 p. <https://doi.org/10.1201/b19559>
2. Grzesik W. *Machining of hard materials*. Machining, Springer, London, 2008. P. 97–126. [https://doi.org/10.1007/978-1-84800-213-5\\_4](https://doi.org/10.1007/978-1-84800-213-5_4)
3. Uhlmann E., Sammler F., Barry J., Fuentes J., Richarz S. Superhard Tools. In: Laperrière, L., Reinhart, G. (eds) *CIRP Encyclopedia of Production Engineering*. Springer, Berlin, Heidelberg, 2014. P. 1183–1188. [https://doi.org/10.1007/978-3-642-20617-7\\_6411](https://doi.org/10.1007/978-3-642-20617-7_6411)
4. Виговський Г. М. Підвищення працездатності торцевих фрез для чистової обробки плоских поверхонь: дис. ... канд. техн. наук: 05.03.01. Київ, 2000. 16 с.
5. Hlembotska L., Melnychuk P., Balytska N., Melnyk O. Modelling the loading of the nose-free cutting edges of face mill with a spiral-stepped arrangement of inserts, *Eastern-European Journal of Enterprise Technologies*. Vol. 9. No. 1. P. 46–54. <https://doi.org/10.15587/1729-4061.2018.121712>
6. Степчин Я. А. Порівняльна характеристика динаміки процесів торцевого фрезерування фрезами стандартних та спеціальних конструкцій. *Вісник ЖДТУ. Серія «Технічні науки»*. 2016. № 1 (72). С. 51–56.
7. Громовий О. А., Виговський Г. М., Балицька Н. О. Шляхи удосконалення процесу обробки плоских поверхонь деталей фрезеруванням. *Технічна інженерія*. 2020. № 2 (86). С. 48–53.
8. Muñoz-Escalona P., Maropoulos P. G. A geometrical model for surface roughness prediction when face milling Al 7075-T7351 with square insert tools. *Journal of Manufacturing Systems*. Vol. 36. 2015. P. 216–223. <https://doi.org/10.1016/j.jmsy.2014.06.011>
9. Hlembotska L., Balytska N., Melnychuk P., Vyhovskyi H. Structural improvement of face mills designs based on systems approach. *Scientific Journal of TNTU*. Vol. 101. No. 1. 2021. P. 102–114. [https://doi.org/10.33108/visnyk\\_tntu2021.01.102](https://doi.org/10.33108/visnyk_tntu2021.01.102)
10. Schultheiss F., Bushlya V., Lenrick F., Johansson D., Kristiansson S., J.E. Ståhl. Tool wear mechanisms of pcBN tooling during high-speed machining of gray cast iron. *Procedia CIRP*. Vol. 77. 2018. P. 606–609. <https://doi.org/10.1016/j.procir.2018.08.201>
11. Soshi M., Fonda P., Kashihara M. et al. A study on cubic boron nitride (CBN) milling of hardened cast iron for productive and quality manufacturing of machine tool structural components. *Int. J. Adv. Manuf. Technol.* Vol. 65. 2013. P. 1485–1491. <https://doi.org/10.1007/s00170-012-4272-3>
12. Sahin Y. Comparison of tool life between ceramic and cubic boron nitride (CBN) cutting tools when machining hardened steels. *Journal of Materials Processing Technology*. Vol. 209. No. 7. 2009. P. 3478–3489. <https://doi.org/10.1016/j.jmatprotec.2008.08.016>
13. Smith G. T. *Cutting Tool Technology*. Industrial Handbook, Springer-Verlag, GmbH, 2008, 600 p.
14. Инструменты из сверхтвердых материалов; под ред. Н. В. Новикова и С. А. Клименко. М.: Машиностроение, 2014. 608 с.
15. Cui X., Zhao J., Tian X. Cutting forces, chip formation, and tool wear in high-speed face milling of AISI H13 steel with CBN tools. *Int. J. Adv. Manuf. Technol.* 2013. No. 64. P. 1737–1749. <https://doi.org/10.1007/s00170-012-4137-9>
16. Kumar Wagri N., Petare A., Agrawal A., Rai R., Malviya R., Dohare S., Kishore K. An Overview of the Machinability of Alloy Steel. *Materials Today. Proceedings*. Vol. 62. No. 6. 2022. P. 3771–3781. <https://doi.org/10.1016/j.matpr.2022.04.457>
17. Иванов Ю. А. Фрезерование корпусных и базовых деталей фрезами, оснащенными резцами из эльбора-Р. *Технология производства, научная организация труда и управления*. 1979. № 2. С. 26–31.
18. Шевченко Н. А., Киппер Э. Е. Чистовые лезвийные инструменты с большим углом наклона режущих лезвий. *Надежность режущего инструмента*. 1975. № 2. С. 222–228.
19. Клименко С. А., Манохин А. С. Твердое «бреющее» точение. *Сверхтвердые материалы*. 2009. № 1. С. 58–74.
20. Klimentenko S. A., Manokhin A. S., Melniichuk Y. A. Wear and life of tools with inserts from cBN-based polycrystalline superhard materials in the finish turning of hardened steels at heavy feeds. *Journal of Superhard Materials*, Vol. 34. No. 1. 2012. P. 49–55. <https://doi.org/10.3103/S1063457612010066>
21. Daoud M., Chatelain J. F., Bouzid A. Effect of rake angle on Johnson-Cook material constants and their impact on cutting process parameters of Al2024-T3 alloy machining simulation. *Int. J. Adv. Manuf. Technol.* Vol. 81. 2015. P. 1987–1997. <https://doi.org/10.1007/s00170-015-7179-y>
22. Shrot A., Bäker M. Is it possible to identify Johnson-Cook law parameters from machining simulations? *International Journal of Material Forming*. Vol. 3. 2010. P. 443–446. <https://doi.org/10.1007/s12289-010-0802-4>



23. Tapoglou N., Antoniadis A. 3-dimensional kinematics simulation of face milling. Measurement. Vol. 45. No. 6. 2012. P. 1396–1405. <https://doi.org/10.1016/j.measurement.2012.03.026>
24. Hlembotska L., Balytska N., Melnychuk P., Melnyk O. Computer modelling power load of face mills with cylindrical rake face of inserts in machining difficult-to-cut materials. Scientific Journal of TNTU. Vol. 93. No. 1. 2019. P. 70–80. [https://doi.org/10.33108/visnyk\\_tntu2019.01.070](https://doi.org/10.33108/visnyk_tntu2019.01.070)
25. Li G., Rahim M. Z., Pan W., Wen C., Ding S. The manufacturing and the application of polycrystalline diamond tools. A comprehensive review. Journal of Manufacturing Processes. 2020. No. 56. P. 400–416. <https://doi.org/10.1016/j.jmapro.2020.05.010>
26. Добротворський С. С., Басова Є. В., Добровольська Л. Г. Комп'ютерне проектування та моделювання технологічних процесів високошвидкісного фрезерування загартованих сталей. Вісник Національного університету «Львівська політехніка». 2015. № 822. С. 7–13.
27. Vyhovskyi H., Plysak M., Balytska N., Hlembotska L., Otamanskyi V. Numerical Simulation of Cutting Forces in Face Milling. Advanced Manufacturing Processes IV. InterPartner 2022. Lecture Notes in Mechanical Engineering, Springer, Cham, 2023. P. 222–231. [https://doi.org/10.1007/978-3-031-16651-8\\_21](https://doi.org/10.1007/978-3-031-16651-8_21)
28. Chernykh D. M., Tkachenko Yu. S., Tsyganov V. S. Simulation of the machining process in order to optimize the operating parameters. Bulletin of the Voronezh State Technical University. Vol. 15. No. 1. 2019. P. 130–137.
29. Vovk A., Sölter J., Karpuschewski B. Finite element simulations of the material loads and residual stresses in milling utilizing the CEL method. Procedia CIRP. Vol. 87. 2020. P. 539–544. <https://doi.org/10.1016/j.procir.2020.03.005>
30. Sheth S., George P. M. Experimental investigation and prediction of flatness and surface roughness during face milling operation of WCB material. Procedia Technol. Vol. 23. 2016. P. 344–351. <https://doi.org/10.1016/j.protcy.2016.03.036>
31. Vyhovskyi H., Plysak M., Balytska N., Melnyk O., Hlembotska L. Engineering methodology for determining elastic displacements of the joint “spindle assembly-face milling cutter” while machining planes. In: Advanced Manufacturing Processes II. InterPartner 2020. Lecture Notes in Mechanical Engineering. Springer, Cham, 2021. P. 258–268. [https://doi.org/10.1007/978-3-030-68014-5\\_26](https://doi.org/10.1007/978-3-030-68014-5_26)
32. Wu W. P. Investigation of the effects of face-milling parameters of ultra-large-scale plane on milling quality. Int. J. Adv. Manuf. Technol. Vol. 37. 2008. P. 241–249. <https://doi.org/10.1007/s00170-007-0976-1>
33. Sheth S., George P. Experimental investigation and optimization of flatness and surface roughness using grey relational analysis for WCB material during face milling operation. Advances in Intelligent Systems Research. Vol. 137. 2017. P. 65–70. <https://doi.org/10.2991/iccasp-16.2017.11>
34. Chauhan P., Patel S., Patel K. Experimenting and predicting flatness and surface roughness during face milling operation of CF8M grade A-351. In: International Conference on Research and Innovations in Science. Engineering & Technology. Vol. 1. No. 1. 2017.
35. Borysenko D., Karpuschewski B., Welzel F., Kundrák J., Felhő C. Influence of cutting ratio and tool macro geometry on process characteristics and workpiece conditions in face milling. CIRP Journal of Manufacturing Science and Technology. Vol. 24. 2019. P. 1–5. <https://doi.org/10.1016/j.cirpj.2018.12.003>

**УДК 621.914.22**

## **ВПЛИВ КОСОКУТНОЇ ГЕОМЕТРІЇ РІЗАЛЬНИХ ЕЛЕМЕНТІВ ЧИСТОВИХ ТОРЦЕВИХ ФРЕЗ НА СИЛИ І ТЕМПЕРАТУРИ РІЗАННЯ**

**Георгій Виговський<sup>1</sup>; Наталія Балицька<sup>1,2</sup>; Микола Плисак<sup>1</sup>;  
Валентин Отаманський<sup>1</sup>**

<sup>1</sup>Державний університет «Житомирська політехніка», Житомир, Україна

<sup>2</sup>Дрезденський технічний університет, Дрезден, Німеччина

***Резюме.** За даними аналізу опублікованих робіт авторів, які досліджували процес фінішної лезової обробки деталей, встановлено доцільність застосування процесів торцевого фрезерування для остаточного формування поверхневого шару деталей, що виготовляються. При цьому значні переваги мають технологічні процеси з використання торцевих фрез косокутного різання, оснащених надтвердими матеріалами, зі спірально-ступінчастим розташуванням різальних елементів. Відомо, що*

косокутна геометрія фрез забезпечує плавне врізування різальних пластин у заготовку і плавний вихід із зони різання, що сприяє зменшенню ударних навантажень на різальні елементи при вході-виході з контакту із заготовкою. За рахунок застосування косокутної геометрії різальних пластин виявляється можливим значно підвищити стійкість торцевих фрез та обробляти поверхні з високою якістю. Дана робота присвячена дослідженню впливу кута нахилу різальної кромки в діапазоні значень від  $\lambda=0^\circ$  до  $\lambda=-45^\circ$  на величину сил різання у процесі обробки плоскої поверхні заготовок із сірого чавуну СЧ-21 та вуглецевої сталі У8 (46 HRC) одним зубом торцевої косокутної фрези за допомогою програми скінченно-елементного аналізу *Deform-3D*. У результаті комп'ютерного моделювання процесу торцевого фрезерування визначено часові реалізації складових сил різання  $P_x$ ,  $P_y$ ,  $P_z$  для наступних умов обробки: подача  $S_z = 0,625$  мм/зуб; швидкість різання  $v = 2,5$  м/с; глибина різання  $t = 0,12$  мм. Обговорено характер залежності складових сил різання  $P_x$ ,  $P_y$ ,  $P_z$  від величини кута нахилу різальної кромки в діапазоні від'ємних значень та взаємозв'язок зі зносостійкістю різальних пластин. Отримані результати будуть застосовані для подальшої оптимізації геометричних параметрів при проектуванні торцевої косокутної фрези, прогнозуванні деформації технологічної системи з метою підвищення ефективності оброблення плоских поверхонь деталей з чавуну та вуглецевої сталі.

**Ключові слова:** торцеве фрезерування, моделювання, косокутне різання, сили різання, чистова обробка.

[https://doi.org/10.33108/visnyk\\_tntu2022.04.054](https://doi.org/10.33108/visnyk_tntu2022.04.054)

Отримано 12.12.2022